

#### 4. Control diagram using External Digital Start Input.

4.1.1 If Start type  $\overline{b\text{-}r}$  is selected as  $\overline{b\text{-}p}$ .

4.1.1.1 If Downcount  $\overline{b\text{-}c}$ =1 and  $\overline{b\text{-}r}$  is  $\overline{b\text{-}n}$  the control diagram is shown in Figure 4.1

4.1.2 If Downcount  $\overline{b\text{-}c}$ =1 and  $\overline{b\text{-}r}$  is  $\overline{b\text{-}f}$  the control diagram is shown in Figure 4.2

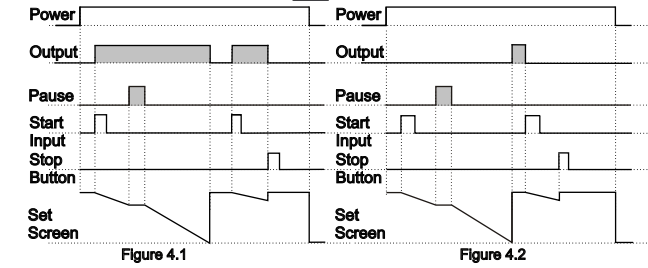

4.2.1 If Upcount  $\overline{b\text{-}c}$ =0 and  $\overline{b\text{-}r}$  is  $\overline{b\text{-}n}$  the control diagram is shown in Figure 4.3

4.2.2 If Upcount  $\overline{b\text{-}c}$ =0 and  $\overline{b\text{-}r}$  is  $\overline{b\text{-}f}$  the control diagram is shown in Figure 4.4

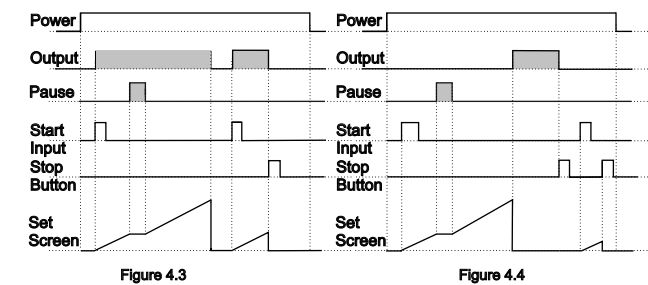

#### 6.5 Entering To The Programming Mode, Changing and Saving Parameter

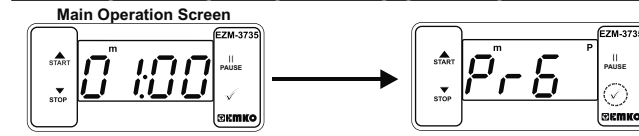

When Enter button is pressed for 5 seconds, "P" led starts to blink. If programming mode entering password is different from 0,  $\overline{r\text{-}5\text{-}t\text{-}f}$  Temperature Unit screen is observed instead of programming screen  $\overline{r\text{-}5\text{-}t\text{-}f}$  will be observed.

**Note1:** If programming mode accessing password is 0,  $\overline{r\text{-}5\text{-}t\text{-}f}$  Temperature Unit screen is observed instead of programming screen  $\overline{r\text{-}5\text{-}t\text{-}f}$  will be observed.

**Programming Mode Entering Screen**  
Press Enter button for accessing to the password entering screen.



**Password Entering Screen**  
Enter programming mode accessing password with increment and decrement buttons.

**Password Entering Screen**  
Press OK button for entering the password.

**Note2:** If programming mode accessing password is 0, only three parameters are accessible, and the parameter values can be changed.

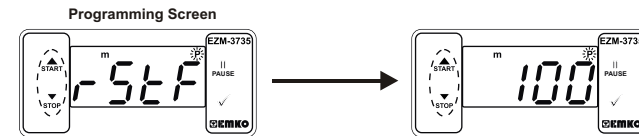

**Programming Screen**  
Press Enter button for accessing to the parameter value. Press increment button for accessing to the next parameter, press decrement button for accessing to the previous parameter.

**Filter Time of Start Input**  
Change the value with increment and decrement buttons.

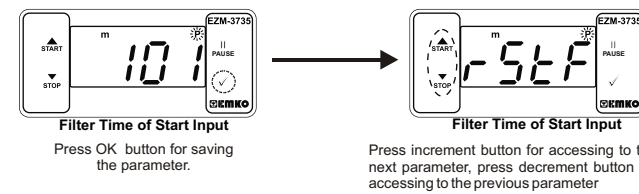

**Filter Time of Start Input**  
Press OK button for saving the parameter.

**Filter Time of Start Input**  
Press increment button for accessing to the next parameter, press decrement button for accessing to the previous parameter.

**i** If no operation is performed in programming mode for 20 seconds, device turns to main operation screen automatically.



Digital Timer Controller



### EzM-3735 77 x 35 DIN Size Digital Timer Controller

- 4 Digits Display
- Operation with One Set value
- Single Contact Output for Timing control ( ON /OFF )
- External Start and Pause Input
- Start and Stop Possibility by front Panel
- Pause possibility by front Panel
- Set value high limit boundaries
- Display can be adjusted to show Second, Minute and Hour
- Programmable Time Bases (Second, Minute, Hour)
- Adjustable internal buzzer according to Timer Stop status.
- Password protection for programming section
- Having CE mark according to European Norms

Instruction Manual. ENG EZM-3735 01 V04 07/17

#### 1. Preface

EZM-3735 Programmable Timer can be used in package machines, production and quality control rollers, and can be adapted easily to all mechanical construction and automation system. Some application fields which they are used are below:

- Application Fields**
- Package machines,
  - Quality Control rollers,
  - Filling Systems,
  - Tool Benches,
  - Building Automation.
  - Production bands

#### 1.1 Environmental Ratings

- Operating Temperature** : 0 to 50 °C
- Max. Operating Humidity** : 90% Rh (non-condensing)
- Altitude** : Up to 2000 m.
- Forbidden Conditions:**
  - Corrosive atmosphere
  - Explosive atmosphere
  - Home applications (The unit is only for industrial applications)

#### 1.2 General Specifications

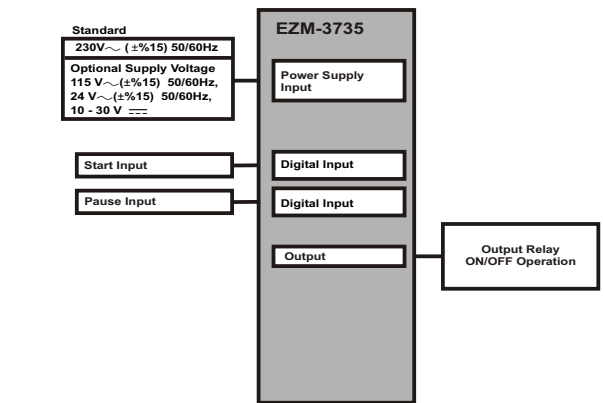

#### 7. Specifications

<b>Device Type</b>	: Digital Timer
<b>Housing&amp;Mounting</b>	: 76mm x 34.5mm x 71mm plastic housing for panel Mounting. Panel cut-out is 71x29mm.
<b>Protection Class</b>	: Ip65 at front, Ip20 at rear.
<b>Weight</b>	: Approximately 0.20 Kg.
<b>Environmental Ratings</b>	: Standard, indoor at an altitude of less than 2000 meters with none condensing humidity.
<b>Storage / Operating Temperature</b>	: -40 °C to +80 °C / -30 °C to +80 °C
<b>Storage / Operating Humidity</b>	: 90 % max. (None condensing)
<b>Installation</b>	: Fixed installation
<b>Overvoltage Category</b>	: II.
<b>Pollution Degree</b>	: II, office or workplace, none conductive pollution
<b>Operating Conditions</b>	: Continuous
<b>Supply Voltage and Power</b>	: 230V~ ( ±%15) 50/60Hz - 1.5VA : 115V~ ( ±%15) 50/60Hz - 1.5VA : 24V~ ( ±%15) 50/60Hz - 1.5VA
<b>Time Accuracy</b>	: within ±%1 error
<b>Digital Start and Pause Inputs</b>	: Mechanical contact
<b>Control Form</b>	: ON / OFF
<b>Relay Output</b>	: 16(8) A@250 V ~ for Resistive load (Output Relay) (Electrical life : 100.000 switching at full load)
<b>Display</b>	: 14 mm Red 4 digits LED Display
<b>LED</b>	: S (Green), P (Green), h (Red), m(Red),s (Red), Output (Red)
<b>Internal Buzzer</b>	: 83dB
<b>Approvals</b>	: CE EAC

#### 8. Ordering Information

EZM-3735 (77x35 DIN Sizes)		A	B	C	D	E	/	F	G	H	I	/	U	V	W	Z
		0	0	1	/	07	07	/	1	0	0	0				
<b>A</b>	<b>Supply Voltage</b>															
3	24V~ ( ±%15) 50/60Hz - 1.5VA															
4	115V~ ( ±%15) 50/60Hz - 1.5VA															
5	230V~ ( ±%15) 50/60Hz - 1.5VA															
8	10 - 30 V ~															
<b>E</b>	<b>Output</b>															
1	Relay Output (16(8) A@250 V ~,at resistive Load, 1 NO+NC )															
<b>FG</b>	<b>Input</b>															
07	Digital Input															
<b>HI</b>	<b>Input</b>															
07	Digital Input															

All order information of EZM-3735 Digital Timer are given on the table at above. User may form appropriate device configuration from information and codes that at the table and convert it to the ordering codes. Firstly, supply voltage then other specifications must be determined. Please fill the order code blanks according to your needs.

Please contact us, if your needs are out of the standards.

- ~ Vac,
- ~ Vdc
- ~ Vdc or Vac can be applied

#### 1.3 Installation

A visual inspection of this product for possible damage occurred during shipment is recommended before installation. It is your responsibility to ensure that qualified mechanical and electrical technicians install this product.

If there is danger of serious accident resulting from a failure or defect in this unit, power off the system and separate the electrical connection of the device from the system.

The unit is normally supplied without a power supply switch or a fuse. Use power switch and fuse as required.

Be sure to use the rated power supply voltage to protect the unit against damage and to prevent failure.

Never attempt to disassemble, modify or repair this unit. Tampering with the unit may result in malfunction, electric shock or fire.

Do not use the unit in combustible or explosive gaseous atmospheres.

During putting equipment in hole on the metal panel while mechanical installation some metal burrs can cause injury on hands, you must be careful.

Montage of the product on a system must be done with it's fixing clamps. Do not do the montage of the device with inappropriate fixing clamp. Be sure that device will not fall while doing the montage.

It is your responsibility if this equipment is used in a manner not specified in this instruction manual.

#### 1.4 Warranty

EMKO Elektronik warrants that the equipment delivered is free from defects in material and workmanship. This warranty is provided for a period of two years. The warranty period starts from the delivery date. This warranty is in force if duty and responsibilities which are determined in warranty document and instruction manual performs by the customer completely.

#### 1.5 Maintenance

Repairs should only be performed by trained and specialized personnel. Cut power to the device before accessing internal parts. Do not clean the case with hydrocarbon-based solvents (Petrol, Trichlorethylene etc.). Use of these solvents can reduce the mechanical reliability of the device. Use a cloth dampened in ethyl alcohol or water to clean the external plastic case.

#### 1.6 Manufacturer Company

**Manufacturer Information:**  
Emko Elektronik Sanayi ve Ticaret A.Ş.  
Demirtaş Organize Sanayi Bölgesi Karanfil Sk. No:6 16369 BURSA/TURKEY  
Phone : +90 224 261 1900  
Fax : +90 224 261 1912

**Repair and maintenance service information:**  
Emko Elektronik Sanayi ve Ticaret A.Ş.  
Demirtaş Organize Sanayi Bölgesi Karanfil Sk. No:6 16369 BURSA/TURKEY  
Phone : +90 224 261 1900  
Fax : +90 224 261 1912

#### 2. General Description

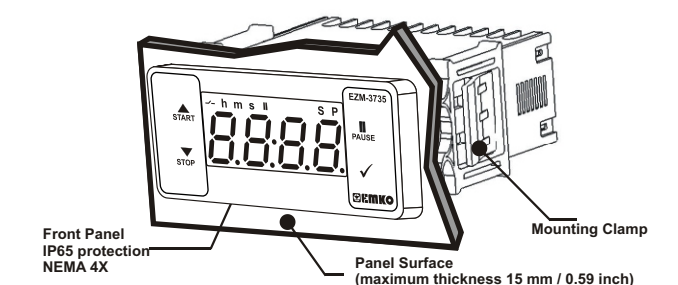

#### 2.1 Front View and Dimensions of EZM-3735 Digital Timer

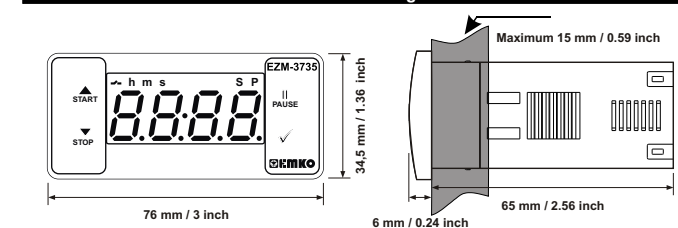

#### 2.2 Panel Cut-Out

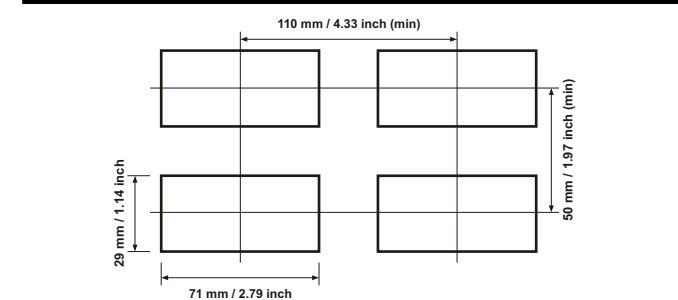

**EMKO** Thank you very much for your preference to use Emko Elektronik products, please visit our Your Technology Partner web page to download detailed user manual. [www.emkoelektronik.com.tr](http://www.emkoelektronik.com.tr)

### 2.3 Panel Mounting

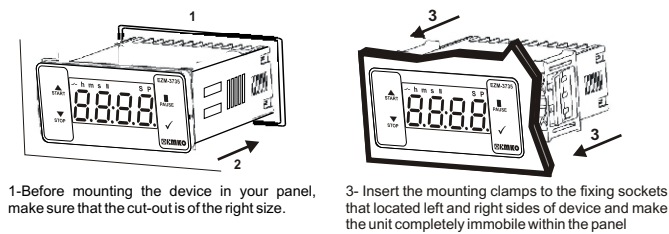

- 1-Before mounting the device in your panel, make sure that the cut-outs of the right size.
- 2-Insert the device through the cut-out. If the mounting clamps are on the unit, put them before inserting the unit to the panel.
- 3- Insert the mounting clamps to the fixing sockets that located left and right sides of device and make the unit completely immobile within the panel

### 2.4 Removing from the Panel

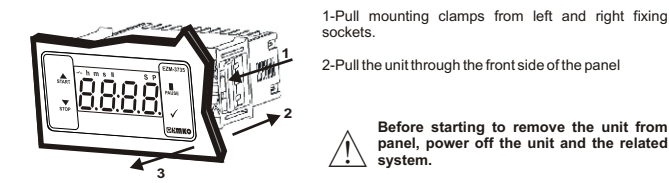

- 1-Pull mounting clamps from left and right fixing sockets.
- 2-Pull the unit through the front side of the panel
- 3- Before starting to remove the unit from panel, power off the unit and the related system.

### 4. Electrical Wiring Diagram

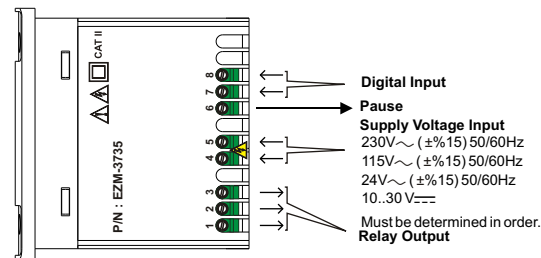

**Note-1 :** For 230V~, 115V~ or 24V~ power supply; input 4 is "L", input 5 is "N", for 10...30 V=== power supply; input 4 is "-", input 5 is "+".

### 4.1 Supply Voltage Input Connection of the Device

**Power Supply Connection** Make sure that the power supply voltage is the same indicated on the instrument. Switch on the power supply only after that all the electrical connections have been completed. Supply voltage range must be determined in order. While installing the unit, supply voltage range must be controlled and appropriate supply voltage must be applied to the unit.

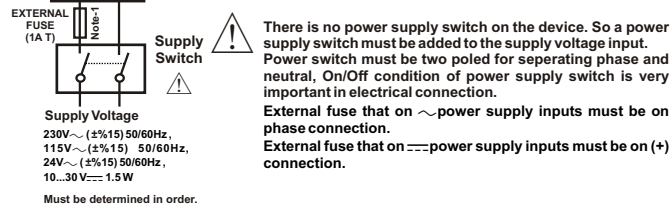

**Note-1 :** External fuse is recommended.  
**Note-2 :** For 230V~, 115V~ or 24V~ power supply; input 4 is "L", input 5 is "N", for 10...30 V=== power supply; input 4 is "-", input 5 is "+".

### 4.2 Device Label and Connection Diagram

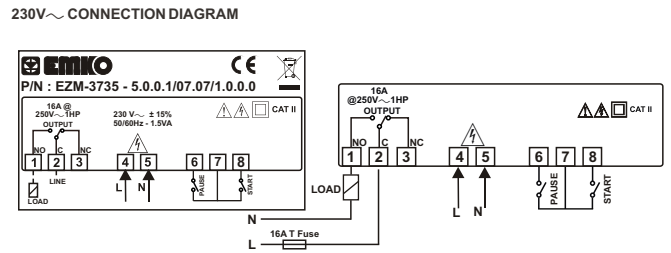

### 5.Front Panel Definition and Accessing to the Menus

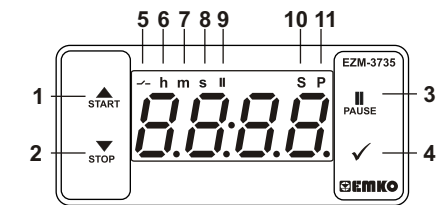

#### BUTTON DEFINITIONS

- 1. Increment Button and Start Button :**  
\*\* It is used to increase the value in the Set screen and Programming mode.  
\*\* It is used for Start the Timer in the Main Screen.
- 2. Decrement, Silencing Buzzer and Stop Button :**  
\*\* It is used to decrease the value in the Set screen and Programming mode.  
\*\* It is used to silence the buzzer.  
\*\* It is used for Stop the Timer in the Main Screen.
- 3. Pause Button :**  
\*\* While digital timer is running if Pause button is pressed or external pause input is activated, timer stops running. After that if the pause button is pressed again or external pause input is deactivated, timer starts running again.
- 4. Enter Button:**  
\*\* In the main operation screen; if this button pressed, set value will be displayed. Value can be changed using increment and decrement buttons. When Set button pressed again, value is saved and returns back to main operating screen.  
\*\* To access the programming screen; in the main operation screen, press this button for 2 seconds.  
\*\* It is used to saving value in the Set screen and programming screen.

#### LED DEFINITIONS

- 5. Output led :**  
\*\* This led indicates that Output is active.
- 6.Hour led :**  
\*\* Indicates that device is in Hour mode.
- 7.Minute led :**  
\*\* Indicates that device is in Minute mode.
- 8.Second led :**  
\*\* Indicates that device is in Second mode.
- 9.Pause led :**  
\*\* This led indicates that Pause is active.
- 10.Set led :**  
\*\* Indicates that device is in Set value changing mode.
- 11.Program led :**  
\*\* Blinks in programming mode.

### 6. Changing and Saving Timing Set Value

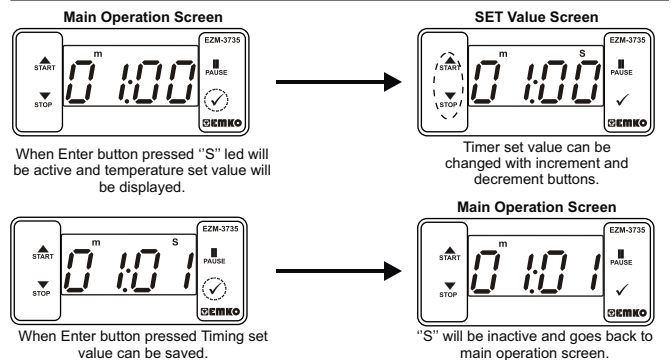

**Timer set value parameter (Default=01:00)**  
Timer set value, can be programmed between minimum Timer set value 00:01 and **UPL** maximum set limit.

#### 6.1 Programming Mode Parameter List

- rstf** Filter Time of Digital Inputs (Default = 100)  
It is used for protection against the electrical contact debounce or the signal that is less than the determined pulse time.  
It can be adjusted from 3 to 250 msec.
- tunt** Time Unit and Scale Selection Parameter (Default = 1)  
**hour** Hour / Minute  
It can be adjusted from 000 to 9999.  
**min** Minute / Second  
It can be adjusted from 000 to 9999.  
**sec** Second / 10 Millisecond  
It can be adjusted from 000 to 9999.
- stcr** Start Type Selection Parameter (Default = **stcr**)  
**stcr** Start / Stop buttons can be used to run or stop the timer.  
**stcr** Start / Stop buttons can be used to run or stop the timer.  
**stcr** External Start Input can be used to run or stop the timer.  
**stcr** External Start Input can only be used to run the timer. In order to stop the timer the Stop button must be used.  
For detailed information refer to graphics.
- outf** Output Functions (Default = **off**)  
**on** if ON is selected timer runs by start and relay contact is closed. When time is over, relay contact opens.  
**off** if OFF is selected timer runs by start. When time is over, relay contact is closed.

- buf** Buzzer Function Selection Parameter (Default = 0)  
If this parameter is selected 0, Buzzer is inactive. Adjustable 16 different buzzer sounds. It can be adjusted from 0 to 16.
- bon** Buzzer is active during this time (Default = **off**)  
Buzzer stays active during this time. It can be adjusted from 1 to 99 seconds. When this parameter is 1, if decrement button is pressed, **off** is observed. In this condition buzzer is active till buzzer Stop button is pressed.
- drEc** Data Record (Default = 1)  
**off** Timer count value is saved to memory when power is disconnected and restored on power up.  
**on** Timer count value is not saved to memory when power is disconnected. When power up, Set value is shown on the screen.
- outt** Output Relay On Delay Time (Default = 0)  
It determines how long output relay will be active. If it is 0000 second, then it operates indefinitely. It can be adjusted from 0000 to 9999 minute/second. This parameter is active only if **outf** is **off**.
- UPL** Maximum Set Value Parameter (Default = 01:00)  
Maximum set value for set time value.  
It can be adjusted from 000 to 9999. (If time value is monitored in milliseconds, **sec**)  
It can be adjusted from 000 to 9999. (If time value is monitored in Hours, **hour** or Minutes, **min**)
- dEc** Timer Counting Direction (Default = 1)  
**off** Timer upcount. 0 to Set value.  
**on** Timer Downcount. Set value to 0.
- prt** Button Protection Parameter (Default = 0)  
**off** Button protection is not active.  
**on** Button protection is active for Timer set value.
- pas** Programming Section Access Password (Default = 0)  
It is used for accessing to the programming section. It can be adjusted from 0 to 9999. If it is selected 0, password will not be asked.

### 2. Control diagram using Start / Stop buttons.

- 2.1 If Start type **stcr** is selected as **stcr**.  
2.1.1 If Downcount **dEc**=1 and **outf** is **on** the control diagram is shown in Figure 2.1  
2.2.2 If Downcount **dEc**=1 and **outf** is **off** the control diagram is shown in Figure 2.2

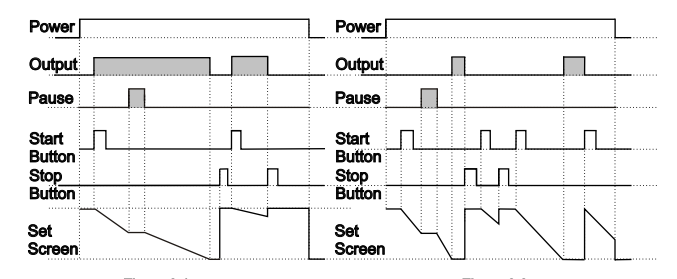

- 2.1.4 If Start type **stcr** is selected as **stcr**.  
2.1.4.1 If Upcount **dEc**=0 and **outf** is **on** the control diagram is shown in Figure 2.3  
2.1.4.2 If Upcount **dEc**=0 and **outf** is **off** the control diagram is shown in Figure 2.4

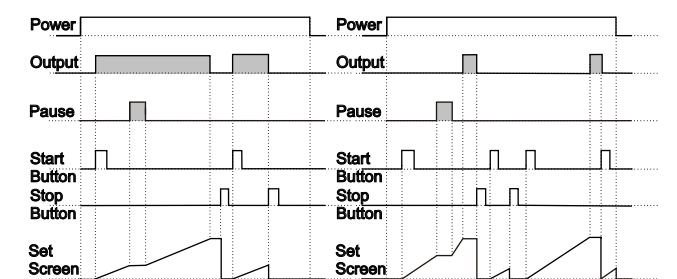

Figure 2.1, Figure 2.2, Figure 2.3, Figure 2.4

### 6.3 Operation Graphics of EZM-3735 Digital Timer

1. Control diagram using Start / Stop buttons.  
1.1 If Start type **stcr** is selected as **stcr**.  
1.1.1 If downcount **dEc**=1 and **outf** is **on** the control diagram is shown in Figure 1.1  
1.1.2 If downcount **dEc**=1 and **outf** is **off** the control diagram is shown in Figure 1.2

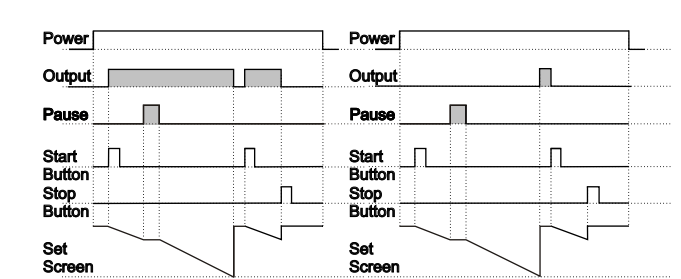

Figure 1.1, Figure 1.2

- 1.2 If Start type **stcr** is selected as **stcr**.  
1.2.1 If Upcount **dEc**=0 and **outf** is **on** the control diagram is shown in Figure 1.3  
1.2.2 If Upcount **dEc**=0 and **outf** is **off** the control diagram is shown in Figure 1.4

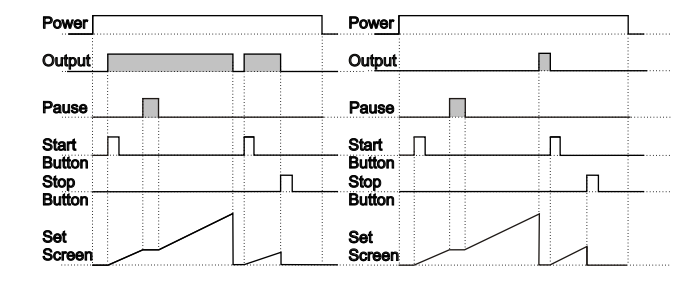
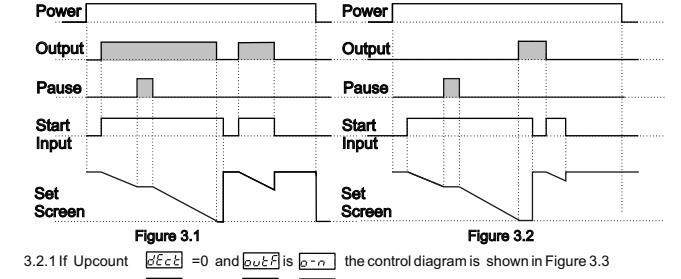

Figure 1.3, Figure 1.4

### 3. Control diagram using External Digital Start Input.

- 3.1 If Start type **stcr** is selected as **stcr**.  
3.1.1 If Downcount **dEc**=1 and **outf** is **on** the control diagram is shown in Figure 3.1  
3.1.2 If Downcount **dEc**=1 and **outf** is **off** the control diagram is shown in Figure 3.2



- 3.2.1 If Upcount **dEc**=0 and **outf** is **on** the control diagram is shown in Figure 3.3  
3.2.2 If Upcount **dEc**=0 and **outf** is **off** the control diagram is shown in Figure 3.4

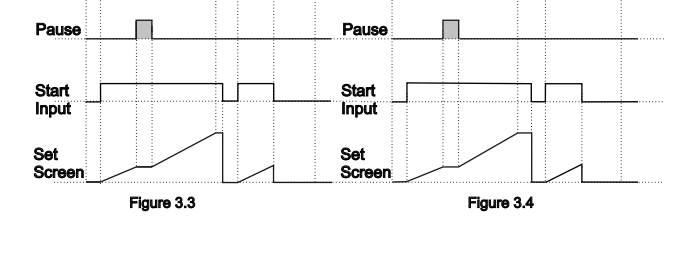

Figure 3.1, Figure 3.2, Figure 3.3, Figure 3.4